

UMTS's LTE WEBCAST

By

Douglas H. Morais
Adroit Wireless Strategies

Sponsored by



The market leaders in LTE field measurements

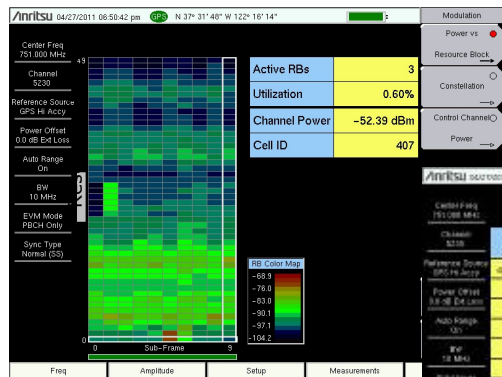

Power vs. Resource Block



LTE OTA Scanner

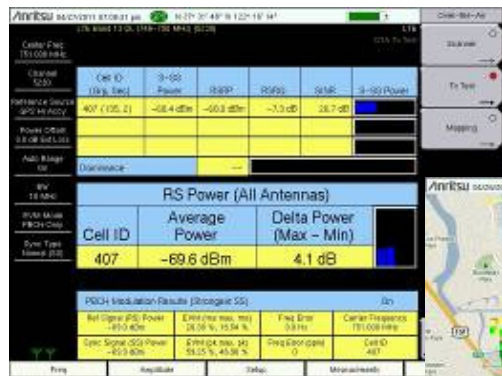

LTE OTA Tx Test



LTE OTA Mapping

➤ Multiple LTE OTA measurements for Remote Radio Head testing:

1. LTE Power vs. Resource Block
Utilize for stress testing & assess sector loading
2. LTE OTA Scanner
Measure S-SS, RSRQ, RSRP, and SINR downlink quality for up to six sectors
3. LTE OTA Tx Test
Verify RF performance for each MIMO (2x2) Tx antenna
4. LTE OTA Mapping
Confirm LTE coverage with on-screen mapping of scanner measurements

Solutions for FDD/TDD LTE field measurements

LTE Bandwidths
Up to 20 MHz



**MT822xB
BTS Master**

LTE Bandwidths
Up to 10 MHz



**MT821xE
Cell Master**



**MS272xC
Spectrum Master**



**MS271xE
Spectrum Master**

➤ BTS Master and Cell Master Base Station Analyzers

- Cable, Antenna, and PIM Analyzer
- Spectrum and Interference Analyzer
- High Accuracy Power Meter
- 3GPP and 3GPP2 Signal Analyzers
- WiMAX Signal Analyzers
- Backhaul Analyzers

➤ Spectrum Master (up to 43 GHz) Spectrum and Signal Analyzers

- Spectrum and Interference Analyzer
- High Accuracy Power Meter
- 3GPP and 3GPP2 Signal Analyzers
- WiMAX Signal Analyzers

Note:

This presentation is based in part on material in
the text

Fixed Broadband Wireless Communications
Principles and Practical Applications

by

Douglas H. Morais

published by

Prentice Hall PTR, © 2004

Unless otherwise stated, all figures and tables in this presentation
are from the text and copyrighted by Prentice Hall PTR.

INTRODUCTION

UMTS Evolution

- Third Generation (**3G**) mobile systems deliver a range of services, including high speed data, telephony, video, paging and messaging.
- The process of broadly defining 3G standards for worldwide application was started by the ITU
- The *Universal Mobile Telecommunications System (UMTS)* is one such 3G wireless system, and is an evolution of the European designed GSM mobile system
- In Europe, the *European Telecommunications Standard Institute (ETSI)* was initially responsible for the UMTS standardization process
- In 1998 the *Third Generation Partnership Project (3GPP)* was created to continue the standardization work under ETSI's auspices
- The first UMTS standard, labeled Release 99 but released in 2000, was for the Wideband CDMA (WCDMA) system
- Since then, there have been additional standard releases, each improving on the performance and data capacity of the previous

INTRODUCTION

UMTS Evolution (cont'd)

- Rel. 5 is labeled *High Speed Downlink Packet Access (HSDPA)*
- Rel. 6 is labeled *High Speed Uplink Packet Access (HSUPA)*, but since it embodies HSDPA and HSUPA, it is often referred to as *High Speed Packet Access (HSPA)*
- Rel.7, referred to as HSPA+, provides improvements to release 6. All releases through Rel. 7 employ CDMA as the core transmission scheme
- Rel.8, released in early 2008, not only improves on HSPA+ performance, but introduces a new architecture, with OFDMA as its core transmission scheme. This new system is referred to as **Long Term Evolution (LTE)**
- Release 9, released in 2010, provides small enhancements
- In this webcast we review the key enabling technologies and performance of LTE, and to a lesser degree, Mobile WiMAX, LTE's primary competitor

SOME KEY LTE TECHNOLOGIES

Basic Modulations

- The fundamental modulation schemes used in the LTE system are all linear and encompass the following:

QPSK, 16-QAM and 64-QAM

- Block diagram of a 2^{2n} -QAM System:

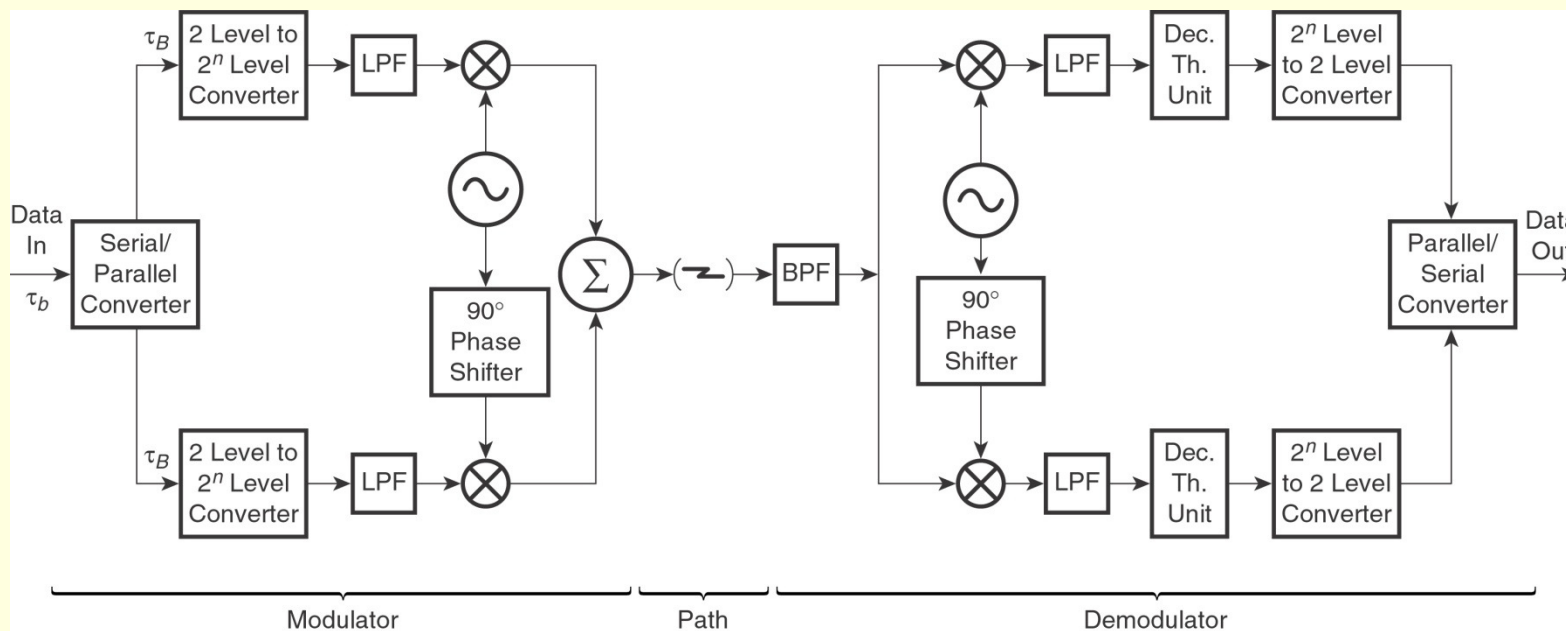

SOME KEY LTE TECHNOLOGIES

Forward Error Correction Coding

- A form of error correction used in LTE is forward error correction (**FEC**)
- In FEC, by the addition of extra bits to the data bit stream per a specific algorithm, the receiver not only detects errors, but corrects errors without having to request retransmission
- FEC results in reduction of both residual BER and receiver threshold level
- As extra bits contribute no new message info, improvement in BER is at the expense of an increase in transmission bit rate
- FEC codes can be classified into **convolution codes (CC)** and **block codes**
- Further, these codes can be combined so as to be decoded in an iterative fashion, creating **Convolution Turbo Codes (CTCs)** or **Block Turbo Coded (BTCs)**
- LTE employs convolution codes and turbo convolution codes

SOME KEY LTE TECHNOLOGIES

Forward Error Correction Coding (cont'd)

- If x is the bit rate into a coding system any y is the bit rate out, then the system is said to have a coding rate of $R = x/y$
- Typical error performance of an uncoded versus FEC coded system:

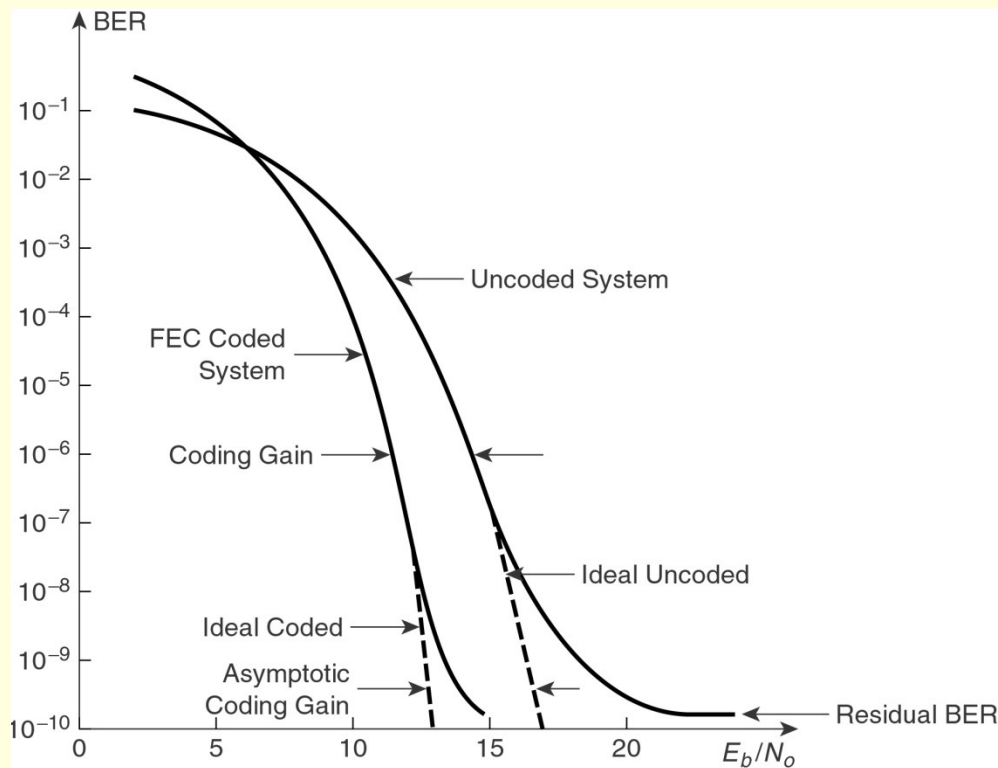

SOME KEY LTE TECHNOLOGIES

Hybrid Automatic Repeat Request (HARQ)

- **Automatic Repeat reQuest (ARQ)** error control is used with packet data systems where data transmission is not continuous
- In this method, by the deliberate introduction of redundancies into the data, the receiver detects packet errors, but makes no attempt to correct packets received in error
- Rather, if a packet error is not detected, an ACK message is sent to transmitter, which then sends the next packet. However, if a packet error is detected, a NACK message is sent to the transmitter which then retransmits the packet in error
- **Hybrid ARQ (HARQ)** employs both FEC and ARQ. By combining the advantages of both these schemes better performance is achieved, especially in time-varying fading channels and channels experiencing fluctuating interference. LTE employs HARQ

SOME KEY LTE TECHNOLOGIES

Adaptive Modulation and Coding

- In any **Base Station/Mobile Station (BS/MS)** link, the higher the modulation level, the higher the link bit rate
- Thus, for maximum system throughput, the goal is to use, in both the DL and UL, the highest modulation level compatible with link conditions
- In **adaptive modulation**, modulation is adjusted automatically per BS/MS link, on a burst-by-burst basis, independently on downstream and upstream
- In **Adaptive Modulation and Coding (AMC)**, not only is modulation adjusted dynamically, but coding as well.
- AMC allows the modulation-coding scheme to be matched to the average channel conditions for each user
- LTE employs AMC

SOME KEY LTE TECHNOLOGIES

Transmission Signal Duplexing

- A transmission signal duplexing scheme is a method of facilitating the transmission and reception of signals on a two-way link
- Three schemes utilized in LTE systems:
 - **Frequency Division Duplexing (FDD)**
 - **Half Duplex-Frequency Division Duplexing (H-FDD)**
 - **Time Division Duplexing (TDD)**
- In **FDD**, DL and UL channels operate on separate frequency channels, thus, all MSs can transmit and receive simultaneously
- In **H-FDD**, DL and UL channels separate, but some or all of MSs cannot transmit and receive simultaneously. Half-duplex mode MSs simplified as antenna coupler now a switch
- In **TDD**, both directions of transmission share the same frequency channel but do not transmit simultaneously, thus, bursty transmission required in both directions

SOME KEY LTE TECHNOLOGIES

Medium Access Control (MAC)

- A key component of the LTE standard is the MAC specification
- In DL direction, BS transmitter is the only transmitter operating and can thus transmit without having to coordinate with other transmitters, except in the case of TDD. However, decisions must be continually made regarding the sharing of the DL resource. This sharing is carried out via **Orthogonal Frequency Division Multiple Access (OFDMA)**
- In UL direction users share transmission medium via **Single Carrier-Frequency Division Multiple Access (SC-FDMA)**
- An efficient mechanism is required to oversee this DL/UL sharing
- This mechanism is called the **Medium Access Control (MAC)**
- The MAC coordinates and schedules transmission among competing MSs with the goal of low latency and good channel utilization
- It can also be designed to allow considerable flexibility in access, providing, for example, varying classes of service

SOME KEY LTE TECHNOLOGIES

Orthogonal Frequency Division Multiplexing (OFDM)

- **OFDM** not a modulation technique, though often loosely referred to as such. Rather, it's a multicarrier transmission technique
- It allows the transmission of data on multiple adjacent subcarriers, each subcarrier being modulated in a traditional manner with a linear modulation scheme such as QAM
- In OFDM, data for transmission is converted into several parallel streams and each stream used to modulate a separate subcarrier
- Thus, only a small amount of the total data is sent via each subcarrier, in a subchannel a fraction of the width of the total channel
- It is this limited data rate per subcarrier that gives OFDM its superior performance in a NLOS multipath environment relative to single carrier transmission
- As MBWA systems operate typically in a NLOS multipath environment, OFDM is well suited to MBWA

SOME KEY LTE TECHNOLOGIES

OFDM (cont'd)

- Standard Frequency Division Multiplexing (FDM) frequency spectrum:

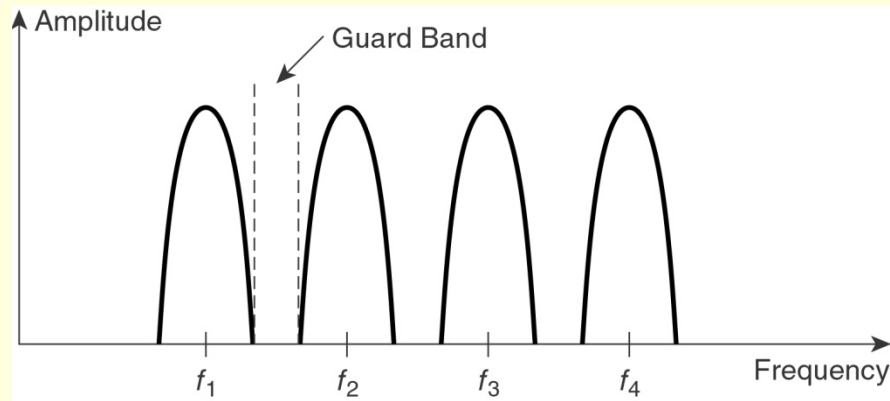

- With OFDM, subcarriers are cleverly stacked close to each other
- This results in overlapping spectra, which eliminates spectral utilization drawback of standard FDM without introducing inter-subchannel interference
- OFDM achieves its close stacking property, without introducing interference, by making subcarriers **orthogonal** to each other

SOME KEY LTE TECHNOLOGIES

OFDM (cont'd)

- Orthogonality accomplished by having:
 - each subcarrier frequency an integer multiple of the symbol rate of the modulating symbols, and
 - each subcarrier separated from nearest neighbor(s) by symbol rate

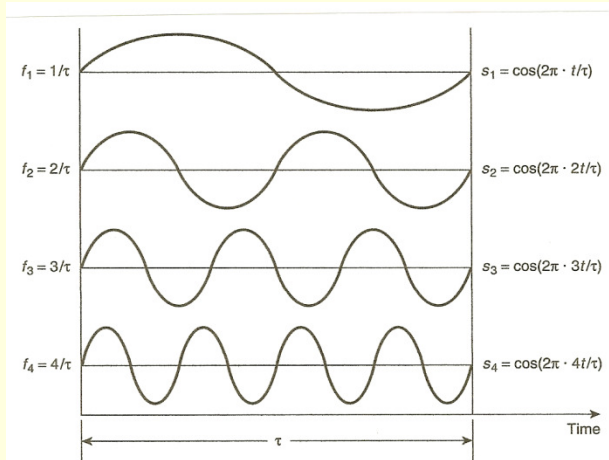

(a) Time Domain Representation of 4 OFDM Sub-Carriers

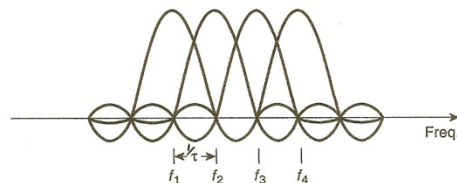

(b) Frequency Domain Representation of 4 OFDM Modulated Sub-Carriers

Adroit Wireless Strategies

SOME KEY LTE TECHNOLOGIES

OFDM (cont'd)

- To avoid construction of a large number of subchannel modulators and demodulators, OFDM systems utilize DSP devices
- Directly as a result of the orthogonality of the OFDM signal structure, modulation is able to be performed by using DSP to carry out **inverse discrete Fourier transform (IDFT)**
- Similarly, demodulation is able to be performed by using DSP to carry out **discrete Fourier transform (DFT)**
- The Fourier transform allows events in the time domain to be related to events in the frequency domain, and vice versa for the Inverse Fourier transform
- Conventional Fourier transform based on continuous signals. However, DFT/IDFT based on signal samples

SOME KEY LTE TECHNOLOGIES

OFDM (cont'd)

- In fact, it's typically a rapid computational version of DFT/IDFT, namely the fast Fourier transform (FFT) and its inverse (IFFT) that's normally used on OFDM realizations
- In an IFFT processor, a signal defined in the frequency domain as a complex number representation, is converted to time domain samples
- Inversely, in an FFT processor, a signal defined in the time domain as samples is converted into one in the frequency domain
- The following figure shows the basic processes in an IFFT/FFT based OFDM system
- Incoming serial data first converted from serial to parallel
- If there are N subcarriers, N set of parallel data streams created
- Each set contains a subset of parallel data streams, depending on the type of modulation

SOME KEY LTE TECHNOLOGIES

OFDM (cont'd)

- Basic IFFT/FFT based OFDM system (see text for details):

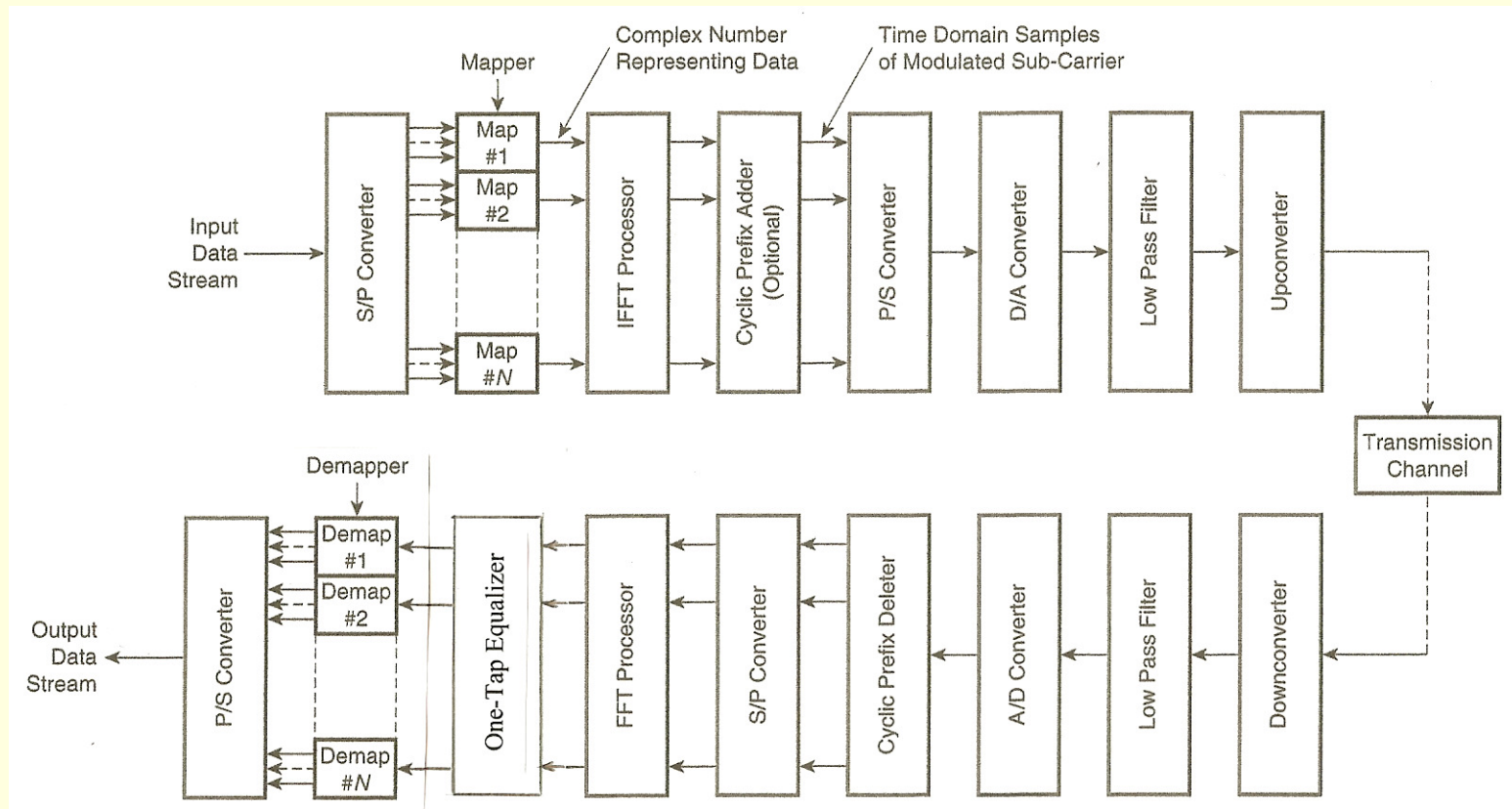

SOME KEY LTE TECHNOLOGIES

OFDMA

- OFDM is the basis of the multi-access technique called **orthogonal frequency division multiple access (OFDMA)**
- With OFDMA, subcarriers are always divided into subchannels
- Subcarriers in each subchannel are spread over the full channel spectrum to minimize multipath fading effects
- OFDMA can be used as a DL access scheme, with the MAC assigning subchannels to the DL data destined to the various MSs. LTE uses OFDMA in the DL.
- OFDMA can also be used as an uplink access scheme, specific subchannels being assigned to specific MSs via MAC messages sent on DLs
- With UL OFDMA, several MS transmitters may transmit simultaneously since each transmits different subchannels and hence subcarriers

SOME KEY LTE TECHNOLOGIES

OFDMA (cont'd)

- Three subchannel frequency assignment example:

Subchannel 1
subcarrier

Subchannel 2
subcarrier

Subchannel 3
subcarrier

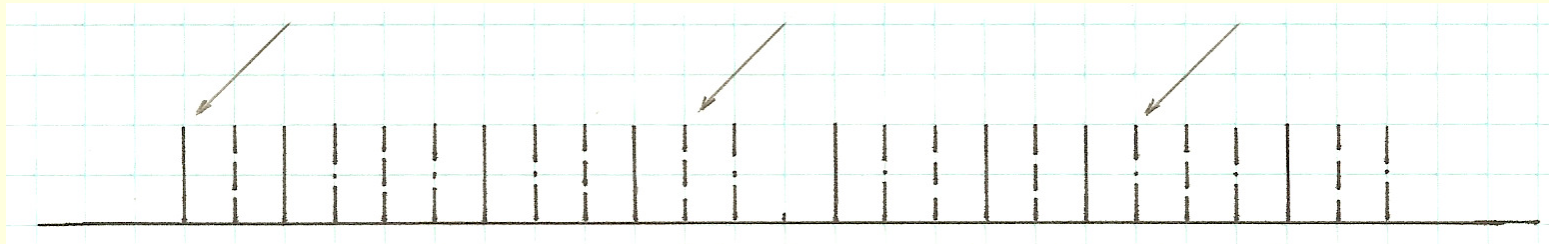

(Above figure not from Fixed Broadband Wireless Communication)

SOME KEY LTE TECHNOLOGIES

Single Carrier FDMA (SC-FDMA)

- **SC-FDMA** is a modified version of OFDMA and used in the LTE UL
- As in OFDMA, the transmitted signal in an SC-FDMA system is a number orthogonal subcarriers.
- Note, therefore, that in SC-FDMA, the transmitted signal is *not* a *single carrier*!
- SC-FDMA's nomenclature comes because, in a specific circumstance, the peak to average power ratio (PAPR) of SC-FDMA is the same as a truly single carrier modulated signal, this PAPR being considerably less than the PAPR with standard OFDMA.
- Even if the above referenced specific circumstance is not met, SC-FDMA PAPR, though more than a truly SC modulated signal, is still less than that with standard OFDMA
- It is this improved PAPR performance of SC-FDMA that drives its implementation.

SOME KEY LTE TECHNOLOGIES

SC-FDMA (cont'd)

- As was shown earlier, OFDM and hence OFDMA takes N data symbols say (a data symbol being a grouping of input bits), runs them through constellation mappers to create subcarriers in the form of complex numbers, then processes these complex numbers by an M -point ($M > N$) IDFT to generate a time signal.
- Thus, within an OFDMA symbol, each subcarrier is modulated with one data symbol.
- SC-FDMA, in contrast, first feeds the N outputs of the mappers into an N -point *DFT* processor which creates subcarriers in the form of complex numbers, then processes these complex numbers by an M -point ($M > N$) IDFT to generate a time signal.
- The output of the DFT processor spreads the input data symbols over all subcarriers.
- This is why SC-FDMA is sometimes referred to (and more correctly so) as *DFT-spread OFDM*

SOME KEY LTE TECHNOLOGIES

SC-FDMA (cont'd)

- Transmitter/Receiver Block Diagrams of OFDMA & SC-FDMA

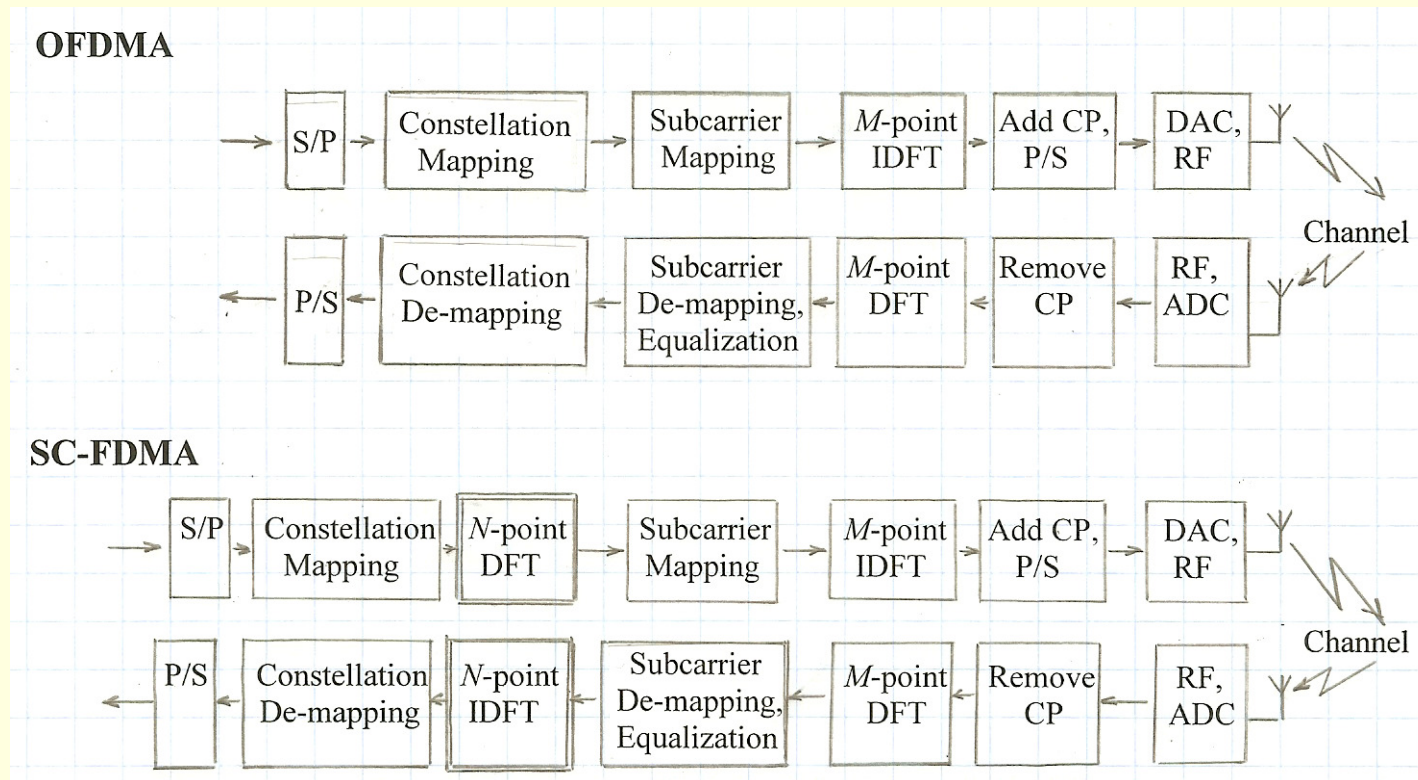

(Above figure not from Fixed Broadband Wireless Communication)

SOME KEY LTE TECHNOLOGIES

Spatial Processing Techniques

- Common to all spatial processing techniques is the use of multiple antennas at the receiver, at the transmitter, or both, together with intelligent signal processing and coding
- The following spatial processing techniques are LTE specified:
 - **Spatial Diversity**
 - **Multiple-Input, Multiple-Output (MIMO)**
 - **Adaptive Antenna System (AAS)**

SOME KEY LTE TECHNOLOGIES

Spatial Diversity (SD)

- **SD** is enacted at the receive end by combining the received signals from multiple antennas, and at the transmit end by transmitting signals via multiple antennas
- Basic principle behind spatial diversity is that physically separated antennas receive signals or transmit signals that travel over different paths and are thus largely uncorrelated regarding fading
- As a result, these signals are unlikely to fade simultaneously
- Thus, by carefully combining them, the average **signal to noise ratio (SNR)** is improved relative to a single transmit, single receive antenna system
- A multiple transmit, single receive antenna system specified as an option in LTE systems is **Space Time Coding (STC)**
- With STC, same data sent via multiple antennas but coded differently. In receiver, STC algorithms and channel estimation techniques used to achieve both diversity and coding gain

SOME KEY LTE TECHNOLOGIES

MIMO Antenna Techniques

- **MIMO** systems very interesting because of their dual capability
- Can be used to provide very robust spatial diversity by combining the features of MISO and SIMO systems. When so used, then an n transmit antenna, m receive antenna system referred to as an $(m \times n)$ th diversity system
- Can also be used to increase capacity with no additional transmit power or channel bandwidth compared to a SISO system
- In such a scheme, n transmit antennas communicate with m receive antennas, where $m \geq n$
- At transmitter, input data divided into n substreams
- These substreams then encoded and used to modulate n carriers, *each occupying the same channel*, and these modulated carriers feed the n antennas
- Thus, a “matrix” channel consisting of $n \times m$ spatial dimensions exists within the same assigned bandwidth

SOME KEY LTE TECHNOLOGIES

MIMO Antenna Techniques (cont'd)

- Clearly, MIMO increases throughput n times compared to SISO, SIMO, or MISO ones
- Below is a simplified block diagram of a capacity-enhancing one-way 2 x 3 MIMO system:

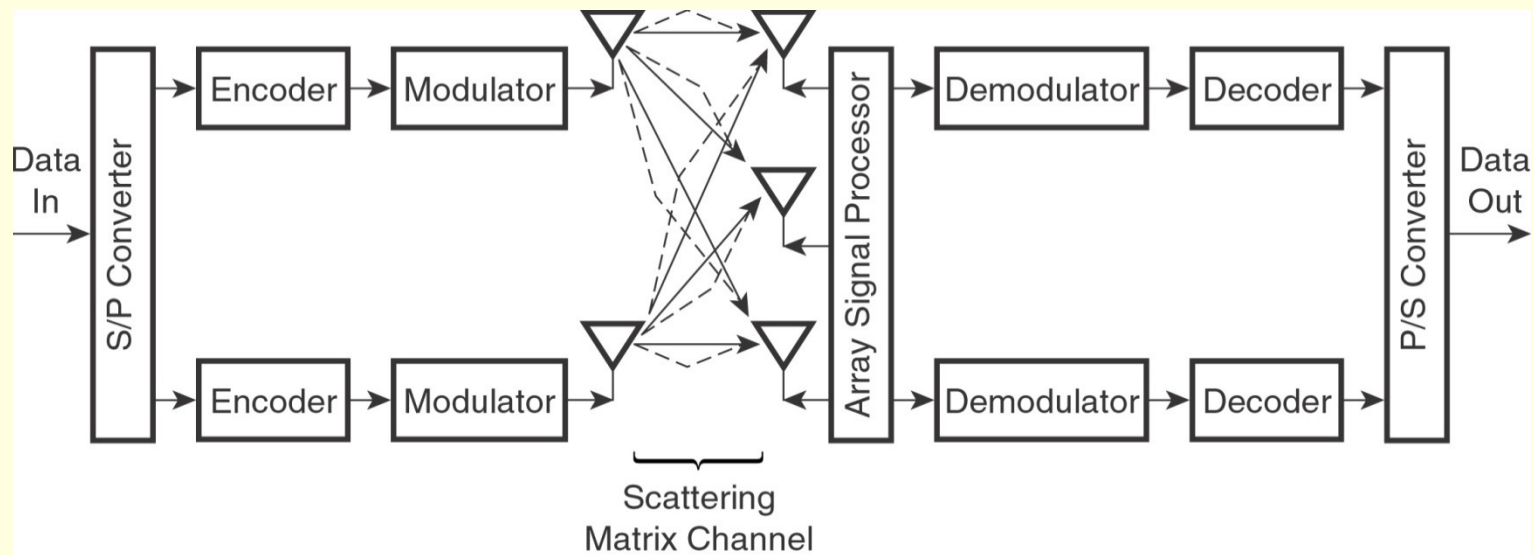

SOME KEY LTE TECHNOLOGIES

Adaptive Antenna Systems (AAS)

- In an Adaptive Antenna System (**AAS**), also called an Adaptive Beamforming system, an array of antennas is used adaptively for reception, transmission, or both, in a way that seeks to optimize transmission over the channel
- In a PMP system, array usually at BS, and forms beams adaptively that target individual remote, not a sector or an entire cell
- Able to do this by creating multiple beams simultaneously, each beam directed to a specific remote
- Shape of each beam can be dynamically controlled so that signal strength to and from a remote is maximized
- Does this by directing main lobe in direction of strongest signal component, and sidelobes in the direction of multipath components

SOME KEY LTE TECHNOLOGIES

Adaptive Antenna Systems (cont'd)

- Further, it can simultaneously minimize interference of signals that arrive at a different direction from the desired by locating nulls in direction of interference, thus maximizing SINR
- Beams from adaptive beamforming antenna array communicating with two remote stations:

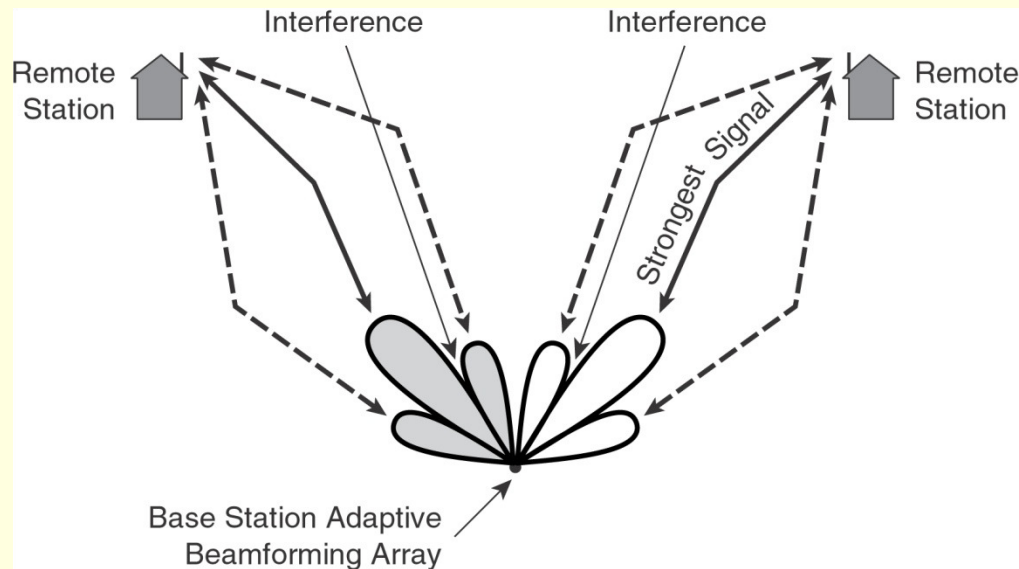

LTE STANDARD

LTE Main Goals

- Main design aims of LTE, a 3G+ technology, are:
 - high data rate ($\geq 100/50$ Mb/s in DL/UL in 20 MHz bandwidth without spatial multiplexing, higher in DL with spatial multiplexing)
 - capability of operating in a wide range of bandwidths (1.4–20 MHz), using FDD, H-FDD and TDD
 - low latency (5 ms roundtrip delay) for small IP packets
 - optimized for 0 to 15 km/hr mobile operation, with support for 15 to 120 km/hr operation
 - co-existence and interworking with other 3GPP technologies such as GSM and HSPA while evolving towards an all IP network
- First commercial release of LTE was made in December 2009 by TeliaSonera in Stockholm and Oslo. As of June, 2011 there were 22 LTE networks in service in 15 countries

LTE STANDARD

LTE Radio Access Overview

- CDMA technology, key to UMTS's High Speed Packet Access (HSPA), abandoned in favor of OFDM based technology. Why? Primarily because of the latter's better robustness, independent of channel bandwidth, in frequency selective fading channels
- DL transmission based on OFDMA
- UL transmission based on DFT-spread OFDM (SC-FDMA)
- Coding on the DL and UL is convolution turbo coding (CTC)
- Modulation on the DL and UL is QPSK, 16-QAM and 64-QAM
- Adaptive Modulation and Coding (AMC) employed on DL and UL
- H-ARQ with soft combining used in LTE
- Several frequency bands supported (currently 13 FDD and 8 TDD), with frequencies ranging from 700 MHz to 3800 MHz

LTE STANDARD

LTE Radio Access Overview (cont'd)

- On both DL and UL, overall time-frequency resource dynamically shared by all users
- Channel conditions in both time and frequency domain taken into account in scheduling decisions, leading to more efficient scheduling
- Multiple antenna technology supported:
 - DL spatial diversity MIMO (2x2) and (4x2)
 - DL spatial multiplexing MIMO (2x2) and (4x2)
 - DL AAS (at the base station)
- Maximum DL user rate of 75 Mb/s without SM, 150 Mb/s with SM
- Maximum UL user rate of 75 Mb/s without SM, 150 Mb/s *system* rate via *collaborative MIMO*
- Enhanced support for Multimedia Broadcast Multicast Services (MBMS)

LTE STANDARD

LTE Overview Chart

- Overview of key parameters and data rates:

Spectrum Allocation	1.4 MHz	3 MHz	5 MHz	10 MHz	15 MHz	20 MHz
Frame Duration	10 ms					
Sub-frame Duration	1 ms					
Slot Duration	0.5 ms					
Useful Symbol Duration	66.7 micro secs					
Subcarrier Spacing	15 kHz					
FFT Size	128	256	512	1024	1536	2048
Number of RBs per subframe	6	15	25	50	75	100
Number of Subcarriers	72	180	300	600	900	1200
DL and UL modulation	QPSK, 16-QAM, and 64-QAM					
Max. practical DL Data Rate per carrier	4.5 MHz	11 Mhz	19 Mhz	37 MHz	56 MHz	75 MHz
Max. practical UL Data Rate per carrier	4.5 MHz	11 MHz	19 MHz	37 MHz	56 MHz	75 MHz
Normal CP length	Symbol 0: 5.21 micro secs, Symbols 1 to 6: 4.69 micro secs					
Extended CP length	Symbols 0 to 5: 16.7 micro secs.					

(Above figure not from Fixed Broadband Wireless Communication)

LTE STANDARD

Beyond LTE: LTE-Advanced

- The ITU started work on so called 4G systems in 2005. It labeled such systems *IMT-Advanced*
- IMT-Advanced systems are expected to provide DL data rates of 100 Mb/s under high mobility and 1 Gb/s under low mobility
- 3GPP's candidate for IMT-Advanced is *LTE-Advanced*, a study item on which was initiated in March 2008
- LTE-Advanced is an evolution of LTE and thus will in many respects be backwardly compatible with LTE
- LTE-Advanced will achieve improved data rates primarily via *carrier aggregation* and increased spatial multiplexing

LTE STANDARD

Beyond LTE: LTE-Advanced (cont'd)

- With Carrier Aggregation:
 - two or more (maximum five) *component carriers* aggregated to create a continuous or non-continuous
 - Total bandwidth of 100 MHz realizable via five 20 MHz
- DL spatial multiplexing expanded to support up to 8x8 MIMO
- UL spatial multiplexing expanded to support 4x4 MIMO
- In October 2010 LTE-Advanced was designated by the ITU as an IMT-Advanced system
- LTE-Advanced specifications were “frozen” in March 2011 and planned for release as part of UMTS Release 10 in late 2011

Mobile WiMAX STANDARD SUMMARY

- Mobile WiMAX is a 3G+ MBWA system. It is based on options of the IEEE 802.16e-2005 standard released in December 2005
- Systems under development/deployment based on profiles released by the WiMAX Forum
- Technology wise, LTE and Mobile WiMAX are *very similar* as will be seen in following slide
- As with LTE, the 802.16e standard supports RF bandwidths of up to 20 MHz. However, the current WiMAX forum released profiles support a maximum RF bandwidth of 10 MHz
- Specifications for a 4G IMT-Advanced version of Mobile WIMAX, have been developed by the IEEE under the 802.16m designation and referred to as *WirelessMAN-Advanced*.
- WirelessMAN-Advanced was accorded ITU IMT-Advanced status in October 2010 and released by the IEEE in March, 2011

LTE and Mobile WiMAX Comparison

- LTE and mobile WiMAX comparison in 10 MHz TDD channel:

Parameter	LTE	Mobile WiMAX
Spectrum Type	Licensed	Licensed
Duplex Method	FDD, TDD	TDD, FDD
DL Access	OFDMA	OFDMA
UL Access	DFTS-OFDM	OFDMA
Channel Bandwidth (MHz)	1.4, 3, 5, 10, 15, 20	3.5, 5, 7, 8.75, 10, 20
DL/UL Frame size (ms)	10/10	5/5
DL/UL Sub-frame size (ms)	1/1	N.A.
Subcarrier Spacing (kHz)	15	10.94
DL and UL Traffic Ch. Coding	CTC	CTC, CC, Repetition
DL and UL Modulation	QPSK, 16-QAM, 64-QAM	QPSK, 16-QAM, 64-QAM
AMC	YES	YES
H-ARQ	YES	YES
MBMS Support	YES	YES
Transmit Diversity, DL	DD, CDD, SFBC	DD, CDD, STBC
SM, DL	2x2	2x2
SM, UL	Collaborative	Collaborative
DL Adaptive Beamforming	YES	YES
# of subcarriers in 10 MHz BW	600	840
~ Total subcarrier BW	600x0.015=9 Mhz	840x0.01094=9.19 Mhz
DL single carrier max. data rate (Mb/s)	37.5 (64-QAM, 5/6R, 10 MHz)	31.7 (64-QAM, 5/6R, 10 MHz)
UL single carrier max. data rate (Mb/s)	36.0 (64-QAM, 5/6R, 10 MHz)	23.5 (64-QAM, 5/6R, 10 MHz)
User plane Latency (Round trip)	<10 ms	<50 ms

(Above figure not from Fixed Broadband Wireless Communication)

LTE CONCLUSION

Conclusion

- LTE first specifications released by 3GPP in 08 under UMTS Rel. 8
- LTE provides maximum practical DL user data rate of about 150 Mb/s with 2 x 2 or 4x2 SM-MIMO and maximum practical UL user data rate of about 75 Mb/s in a 20 MHz channel
- First commercial LTE release was in Dec. 2009 by TeliaSonera in Stockholm and Oslo. Several additional releases in 2010 and 2011.
- LTE-Advanced specifications to be released in late 2011. LTE-Advanced will significantly improve data rate and performance of LTE
- Only Mobile WiMAX likely to be LTE's primary competitor from a technology perspective

LTE CONCLUSION

Conclusion (cont'd)

- LTE and Mobile WiMAX very similar in design and performance, with primary differences being:
 - DFTS-OFDM in LTE UL versus OFDMA in Mobile WiMAX, resulting in likely higher MS average transmitter power and/or lower battery drain in LTE relative to Mobile WiMAX
 - A 1 ms user plane TTI in LTE versus 5 ms in Mobile WiMAX, resulting in lower user plane latency in LTE versus Mobile WiMAX
- Above differences not likely to have large impact on market acceptability
- Mobile WiMAX commenced deployment in early 2009 and thus had about a one year head start over LTE
- On the other hand, LTE is a UMTS evolution system, and thus has a large installed base to build upon

LTE CONCLUSION

Conclusion (cont'd)

- Bottom line is that both LTE and Mobile WiMAX will likely find market acceptance and deployment
- Unknown is in what proportion they will share the high-speed MBWA market pie, but LTE appears to be gaining upper hand
- 3G & 3G+ technology used/planned by major U.S. service providers:

	<u>AT&T</u>	<u>VERIZON</u>	<u>T-MOBILE</u>	<u>SPRINT</u>
3G	HSPA	EV-DO	HSPA	EV-DO
3G+	HSPA+/LTE	LTE	HSPA+	WiMAX

- LTE chosen by U.S. Public Safety Organizations (PSOs) for future deployments

Note: Verizon, AT&T and PSOs plan to operate LTE in 700 MHz band.

Sprint operates WiMAX in the 2.5 GHz band

CONCLUSION

Conclusion (cont'd)

- For an in depth study of LTE technology, consider enrollment in the Besser Associates two-day course “LTE Mobile Access”, planned for presentation by me on August 18-19 in San Jose. To learn more about this course visit www.besserassociates.com. Webinar attendees will receive a \$100 discount if they register by July 22nd. Please contact info@besserassociates.com for details.